



FINISH THOMPSON INC.

DB22 SERIES

ASSEMBLY, INSTALLATION AND OPERATION MANUAL

Literature ID No. FT08-1023F, R7

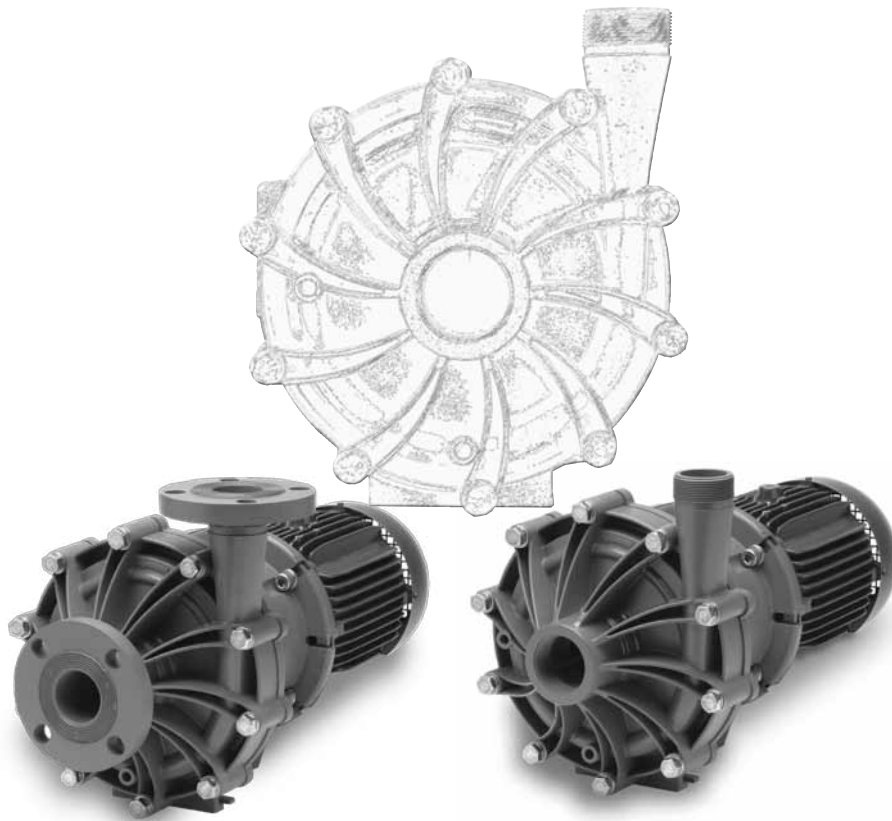



FINISH THOMPSON INC.

921 Greengarden Road • Erie, PA 16501-1591 U.S.A.
Ph 814-455-4478 • Fax 814-455-8518
Email fti@finishthompson.com • www.finishthompson.com

EU Declaration of Conformity



Finish Thompson Inc. hereby declares that the following machine(s) fully comply with the applicable health and safety requirements as specified by the EC Directives listed. The product may not be taken into service until it has been established that the drive motor for the centrifugal pump complies with the provisions of all relevant EC Directives. The complete product complies with the provisions of the EC Directive on machinery safety provided motors carry CE marking. This declaration is valid provided that the devices are fully assembled and no modifications are made to these devices.

Type of Device:
Centrifugal Pumps

Models:		
AC/AK/AV - 400/500/600/800	DB-6/6H/7/8/9/10/11/15/22	GP-11/22/32
KC-3/4/5/5.5/6/6H/8/10/11/22/32	MSKC	MSVKC
SP-10/11/15	UC-1516/1518/326	VKC-5.5/6/6H/7/8/10

EC Directives:
Machinery Safety (2006/42/EC)

Applied Harmonized Standards:
EN ISO 12100 Part 1
EN ISO 12100 Part 2
EN 809

Manufacturer:
Finish Thompson Inc.
921 Greengarden Road
Erie, Pennsylvania 16501-1591 U.S.A

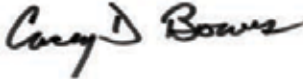
Signed,

President

January 21, 2010

Person(s) Authorized to Compile Technical File: Michael Smith Engineers Limited
Oaks Road, Woking, Surrey
GU21 6PH, UK
Telephone: 01483 771871

TABLE OF CONTENTS

Description	Page Number
Model Number/Serial Number	4
Important Notice	4
Chemical Reaction Disclaimer	4
Safety Precautions for ATEX Pumps	4
Temperature Classification	5
DB22 Capabilities	
Maximum Working Pressure	6
Maximum Temperature.....	6
Solids	6
Minimum Flow Rate	6
Maximum Motor Power	6
Maximum Specific Gravity.....	6
Section I - Assembly.....	7
Section II - Installation.....	8
Section III - Start-up and Operation	
Start-up	9
Shutdown.....	9
Flush Systems.....	9
Optional Drain installation.....	9
Section IV - Maintenance	
Disassembly.....	9
Outer Drive Replacement.....	10
Thrust Ring Replacement	10
Bushing Replacement.....	11
Impeller Replacement.....	11
Reassembly.....	11
DB22 Part Number Explanation	12
DB22 Exploded View Parts Diagram.....	13
Spare Parts List	14-17
Troubleshooting.....	18
Section V - Warranty.....	18

Note: Maintenance videos are now available on line at www.finishthompson.com.

For factory assistance with repairs or maintenance, call 1-800-888-3743.



FINISH THOMPSON INC.

921 Greengarden Road • Erie, PA 16501-1591 U.S.A.

Ph 814-455-4478 • Fax 814-455-8518

Email fti@finishthompson.com • www.finishthompson.com

Model Number and Serial Number

Record the model number and serial number below for future reference. This is important information when ordering replacement parts or when technical assistance is required. The numbers are found on a label located on the motor adapter.

MODEL NUMBER _____

SERIAL NUMBER _____

IMPORTANT NOTICE

U.S. Export Administration Regulations, pursuant to ECCN 2B350, prohibit the export or reexport to certain enumerated countries of sealless centrifugal pumps in which all wetted materials are constructed from fluoropolymers without first applying for and obtaining a license from the U.S. Bureau of Industry and Security (BIS). This affects all Finish Thompson magnetic-drive pumps constructed from PVDF or lined with ETFE. Please contact the BIS (www.bis.doc.gov) or Finish Thompson with questions regarding the Regulations or a list of the countries to which they apply.

Chemical Reaction Disclaimer

The user must exercise primary responsibility in selecting the product's materials of construction, which are compatible with the fluid(s) that come(s) in contact with the product. The user may consult Finish Thompson, Inc. (manufacturer) and a manufacturer's representative/distributor agent to seek a recommendation of the product's material of construction that offers the optimum available chemical compatibility.

However neither manufacturer nor agent shall be liable for product damage or failure, injuries, or any other damage or loss arising out of a reaction, interaction or any chemical effect that occurs between the materials of the product's construction and fluids that come into contact with the product's components.

Safety Precautions

 **WARNING:** READ THIS MANUAL COMPLETELY BEFORE INSTALLING AND OPERATING THIS UNIT. FAILURE TO FOLLOW THESE PRECAUTIONS CAN RESULT IN SERIOUS INJURY OR DEATH.

 **WARNING:** Magnetic field hazard. This pump contains powerful magnets. Exposed magnets (pump not connected to motor) produce powerful magnetic fields. Individuals with cardiac pacemakers, implanted defibrillators, other electronic medical devices, metallic prosthetic heart valves, internal wound clips (from surgery), metallic prosthetic devices or sickle cell anemia must not handle or be in the proximity of the magnets contained inside the pump. Consult a health care provider for specific recommendations before working with this pump.

 **WARNING:** Magnetic force hazard. This pump should only be disassembled and assembled using the recommended procedures. The magnetic attraction is powerful enough to rapidly pull the motor end and the wet end together. Do not place fingers between the mating surfaces of the motor and wet ends to avoid injuries. Keep the drive magnet and impeller assembly away from metal chips or particles, items with magnetic stripes like credit cards and magnetic computer media such as floppy discs and hard drives.

 **WARNING:** Hot surfaces. This pump is capable of handling liquids with temperatures as high as 220° F (104° C). This may cause the outer areas of the pump to become hot as well and could cause burns.

 **WARNING:** Rotating Parts. This pump has components that rotate while in operation. Follow local safety standards for locking out the motor from the power supply during maintenance or service.

 **WARNING:** Chemical Hazard. This pump is used for transferring many types of potentially dangerous chemicals. Always wear protective clothing, eye protection and follow standard safety procedures when handling corrosive or personally harmful materials. Proper procedures should be followed for draining and decontaminating the pump before disassembly and inspection of the pump. There may be small quantities of chemicals present during inspection.

⚠ WARNING: Never run pump at less than minimum flow or with the discharge valve closed. This could lead to pump failure.

⚠ WARNING: The pump and associated components are heavy. Failure to properly support the pump during lifting and movement could result in serious injury or damage to the pump and components.

⚠ CAUTION: This pump should never be started without liquid in the casing. If the pump has a PTFE, ceramic or silicon carbide bushing, IT CANNOT BE RUN DRY WITHOUT CAUSING DAMAGE TO THE PUMP. It is recommended that run dry protection be used. Optional electronic power monitors are available to help protect against run dry. However, the pump can operate without liquid in the housing if the pump has a carbon bushing. The exact length of time the pump can operate dry with a carbon bushing varies with operating conditions and environment.

⚠ CAUTION: Never start or operate with a closed suction valve.

⚠ WARNING: Operation without priming or against a closed discharge valve can result in high temperatures that can result in injury or damage to pump components.

⚠ CAUTION: Always provide adequate NPSHa (net positive suction head available). It is recommended to provide at least 2 feet (61 cm) above the NPSHr (net positive suction head required).

⚠ CAUTION: If pump is used on variable speed drive, do not exceed the frequency for which the pump was designed (for example, if the pump is a 50 Hz model, do not exceed 50 Hz).

Safety Precautions for ATEX Pumps

⚠ CAUTION: Proper o-ring material must be chosen for the fluid being pumped. Improper material selection could lead to swelling and be a possible source of leaks. This is the responsibility of the end user.

⚠ WARNING: The pump must be checked for leaks on a regular basis. If leaks are noticed, the pump must be repaired or replaced immediately.

⚠ WARNING: The pump must be cleaned on a regular basis to avoid dust buildup greater than 5 mm.

⚠ WARNING: ATEX pumps must use a power monitor, flow switch, pressure switch or similar device to help protect against running dry, closed discharge valve and decoupling. Any of these conditions could lead to a rise in surface temperature of the pump.

Temperature Classification

The surface temperature of DB Series pumps depends upon the temperature of the fluid that is being pumped. The following chart lists different fluid temperatures and the corresponding pump surface temperature.

Fluid Temperature	Maximum Surface Temperature	Temperature Class	Maximum Allowable Surface Temperature
85° F (36° C)	136° F (58° C)	T6	85° C
170° F (77° C)	178° F (81° C)	T5	100° C
220° F (104° C)	203° F (95° C)	T4	135°

DB22 Capabilities

Maximum Working Pressure: 90psi (6.2 bar)

Maximum Temperature: Polypropylene -180° F (82° C); PVDF – 220° F (104° C)

NOTE: Maximum temperature is application dependent. Consult a chemical resistance guide or the chemical manufacturer for chemical compatibility and temperature limits.

Solids: Maximum particle size is 100 microns for slurries and 1/64” (.4 mm) for occasional solids. Maximum hardness is 80 HS. Maximum concentration is 10% by weight.

NOTE: If solids are being pumped, it is recommended that the pump have either ceramic or, for best results, silicon carbide components. Pumping solids may lead to increased wear.

Minimum Allowable Flow Rate - Do not allow the flow rate to drop below 10 gallons per minute (2.3 m3/hr).

Maximum Allowable Motor Power

Do not exceed 7.5 kW (10 horsepower) for 50 Hz, 2900 rpm applications. For 60 Hz, 3450 rpm applications, the pump is capable of starting a 15 horsepower motor but is limited to a maximum of 13 horsepower (9.7 kW) while running. Use the information in the chart below to determine the maximum specific gravity capabilities by impeller trim for non-overloading applications. The use of a power monitor is strongly recommended for 60 Hz applications above 10 horsepower (7.5 kW).

Maximum Specific Gravity for Non-Overloading Applications

3450 rpm (60 Hz)	
Closed Impeller Diameter	Maximum Specific Gravity
7.25" (184.2 mm)	1.0
7" (177.8 mm)	1.1
6.5" (165.1 mm)	1.5
6" (152.4 mm)	1.8
5.5" (139.7 mm)	1.8
5" (127.0 mm)	1.8
4.5" (114.0 mm)	1.8

2900 rpm (50 Hz)	
Closed Impeller Diameter	Maximum Specific Gravity
184.2 mm (7.25")	1.35
177.8 mm (7")	1.6
165.1 mm (6.5")	1.8
152.4 mm (6")	1.8
139.7 mm (5.5")	1.8
127.0 mm (5")	1.8

3450 rpm (60 Hz)	
Open Impeller Diameter	Maximum Specific Gravity
6" (152.4 mm)	1.5
5.5" (139.7 mm)	1.8
5" (127.0 mm)	1.8
4.5" (114.0 mm)	1.8

2900 rpm (50 Hz)	
Open Impeller Diameter	Maximum Specific Gravity
181.0 mm (7.13")	1.35
177.8 mm (7")	1.5
165.1 mm (6.5")	1.75
152.4 mm (6")	1.8
139.7 mm (5.5")	1.8

DB22 Assembly, Installation and Operation

Unpacking and Inspection

Unpack the pump and examine for any signs of shipping damage. If damage is detected, save the packaging and notify the carrier immediately.

Section I - Assembly

Tools Required:

3/8" Allen wrench or ballpoint hex socket, 3/16" Allen wrench, 19 mm hex socket, metric socket set (for pumps with IEC outer drives)

Pumps with Motors

Proceed to "Installation" Section

Pumps Without Motors

NOTE: All motors must have motor feet

1. Remove the pump, drive magnet assembly and hardware package from the carton. For 184TC motors proceed to step 3.

CAUTION: Keep away from metallic particles, tools and electronics. Drive magnets MUST be free of metal chips.

WARNING: Keep the drive magnet away from the open end of the motor adapter and barrier. Strong magnetic attraction could allow the drive hub to enter the motor adapter resulting in injury or damage.

2. For 213/215 NEMA motors only – Install the o-ring (item 10A) in the groove in the motor adapter. Use small amount of petroleum jelly (or silicone grease on EPDM o-rings) to help hold the o-ring in place. Install the larger female rabbit portion of the motor adapter flange (item 10) on the motor face. Align the holes in the adapter with the holes in the motor face. See figure 1.

For 90; 100/112; 132 with B5 flange motors

Install flange (item 10) on motor with the side with pockets (depressions) towards the motor face. Align (4) holes in the adapter with the holes in the motor face. Install (4) customer supplied bolts, lock washers and flat washers through the motor adapter into the motor face.

For 90; 100/112; 132 with B14 flange motors

Install flange (item 10) on motor with pockets (depressions) side towards the motor face. Align (4) holes in the adapter with the holes in the motor face. Install (4) bolts, lock washers and flat washers (items 20, 21, 22) through the motor adapter into the motor face. See figure 1.

Flange hole thread size:

90 B5 = M10 x 1.5

100/112 B5 = M12 x 1.75

132 B5 = M12 x 1.75

Torque bolts to the following:

90/100/112 B14 frame (M8) = 130 in-lb (14.7 N-m)

132 B14 (M10) frame (M10) = 240 in-lb (27.1 N-m)

90 frame B5 (M10) = 240 in-lb (27.1 N-m)

100/112/132 B5 (M12) = 480 in-lb (54.3 N-m)



Figure 1

3. Coat the motor shaft with anti-seize compound. Insert key supplied with motor into keyway on motor shaft.

NOTE: Make sure the motor shaft is clean and free of burrs. The outer drive is precision machined and has a bore tolerance of $+.0005/-0$ inch.

4. Slide the outer drive magnet assembly (item 9) onto the motor shaft until the motor shaft contacts the snap ring in the bore of the drive. Figures 2 and 3.



Figure 2



Figure 3

WARNING: Be careful, magnets will try to attract tools.

Metric Motors: Secure the drive to the motor shaft using bolt, lock washer and flat washer (items 17, 18, 19). Thread the bolt into the end of the motor shaft (while holding the outer drive to prevent it from turning). See figure 4.

Tighten the bolt to the following:

- 90 frame (M8) = 130 in-lb (14.7 N-m)
- 100/112 frame (M10) = 240 in-lb (27.1 N-m)
- 132 frame (M12) = 480 in-lb (54.3 N-m)

NEMA Motors: Install set screws (item 9B) into threaded holes on the side of the outer drive magnet assembly. Using a 3/16" Allen wrench, tighten to 228 in-lbs (25.8 N-m). See figure 5.



Figure 4



Figure 5

5. Install the pump end on the motor/drive magnet assembly.

NOTE: If the pump has the optional o-ring sealing option (available on 184 and 215 frame pumps only), install the o-ring (item 8B) in the groove in the motor adapter (motor end). Use small amount of petroleum jelly (or silicone grease on EPDM o-rings) to help hold the o-ring in place.

Place the motor/drive on a flat surface with the drive and motor face hanging over the bench surface. Secure the motor to the bench.

Firmly grab the pump and slide over the outer drive magnet until the motor adapter is seated in the rabbet of the motor (184TC) or the motor adapter flange. The last 4-5" (10-12 cm) will have strong magnetic attraction between the pump and outer drive magnet. See figures 6 and 7.

NOTE: The clearance between the motor adapter and drive magnet is tight (about .010"/.254 mm).



Figure 6



Figure 7

6. Secure the pump to the motor using (4) 1/2" socket head cap screws, lock washers and flat washers (items 14, 15, 16). Use 3/8" Allen wrench or 3/8" hex socket on universal joint. See figures 8 and 9.



Figure 8



Figure 9

7. Rotate the motor fan to ensure that there is no binding in the pump.
8. Proceed to Installation Section

Section II - Installation

Mounting – Pump foot should be securely fastened to a solid foundation. If the pump was received with plastic shipping shims, these may be used as additional support for the motor feet.

CAUTION: The NPSH available to the pump must be greater than the NPSH required. NPSH available should be two feet (.6 meters) greater than NPSH required.

- Install the pump as close to the suction source as possible.
- Support the piping independently near the pump to eliminate any strain on the pump casing. In addition, the piping should be aligned to avoid placing stress on the pump casing.
- The suction side of the pump should be as straight and short as possible to minimize pipe friction.
- The suction line should not have any high spots. This can create air pockets that can reduce pump performance. The suction piping should be level or slope slightly upward to the pump.
- If flexible hose is preferred over pipe, use a reinforced hose rated for the proper temperature, pressure and is chemically resistant against the fluid being pumped.
- The suction valve must be completely open to avoid restricting the suction flow.
- When installing pumps with flanges, we recommend use of low seating stress gaskets such as Gore-Tex or Gylon (expanded PTFE).

Motor/Electrical

Install the motor according to NEC requirements and local electrical codes. The motor should have an overload protection circuit.

Wire the motor for clockwise rotation when facing the fan end of the motor.

CAUTION: Do not operate the pump to check rotation until the pump is full of liquid.

Check all electrical connections with the wiring diagram on the motor. Make sure the voltage, frequency, phase and amp draw comply with the supply circuit.

To verify correct rotation of the motor:

1. Install the pump into the system.
2. Fully open the suction and discharge valves.
3. Allow fluid to flow into the pump. Do not allow the pump to run dry (ceramic, PTFE and silicon carbide bushings can't be run dry without damage to pump components).
4. Jog the motor (allow it to run for 1-2 seconds) and observe the rotation of the motor fan. Refer to the directional arrow molded into the pump casing if necessary.

NOTE: A pump running backwards will pump but at a greatly reduced flow and pressure.

Section III - Start-up and Operation

Start-up and Operation

1. This pump must be filled from a flooded suction tank (gravity) or primed with liquid from an outside source. The DB22 is not self-priming.
2. Open the inlet (suction) and discharge valves completely and allow the pump to fill with liquid.
3. Close the discharge valve.
4. Turn the pump on. Slowly open the discharge valve. Adjust the flow rate and pressure by regulating the discharge valve. Do not attempt to adjust the flow with the suction valve.

Shutdown

1. Use the following procedure to shutdown the pump.
2. Slowly close the discharge valve.
3. Turn off the motor.
4. Close the suction valve.

Flush Systems

 **CAUTION:** Some fluids react with water; use compatible flushing fluid.

1. Turn off the pump.
2. Completely close the suction and discharge valves
3. Connect flushing fluid supply to flush inlet valve.
4. Connect flushing fluid drain to flush drain valve.
5. Open flushing inlet and outlet valves. Flush system until the pump is clean.

Optional Drain Installation

1. Remove the impeller housing (item 1) from the pump assembly.
2. Clamp the impeller housing to a drill press table.
3. Using a 7/16" drill and the molded boss as a guide, drill completely through the molded boss into the interior of the impeller housing.

 **CAUTION:** Do not tap too deep or the impeller housing may be damaged.

4. Using a 1/4" NPT tap, tap the hole in the molded boss to the appropriate depth.
5. Install the drain plug or valve, being careful not to over-tighten.

Section IV - Maintenance

Recommended maintenance schedule

The recommended maintenance schedule depends upon the nature of the fluid being pumped and the specific application. If the pump is used on a clean fluid, it is recommended that the pump be removed from service and examined after six months of operation or after 2,000 hours of operation. If the pump is used on fluids with solids, high temperatures or other items that could cause accelerated wear, then this initial examination should be sooner.

After the initial examination of the internal components and wear items are measured, a specific maintenance schedule can be determined. For best results, it is recommended that the pump be removed from service annually for examination.

Disassembly

 **WARNING:** Rotating Parts. This pump has components that rotate while in operation. Follow local safety standards for locking out the motor from the power supply during maintenance or service.

 **WARNING:** Chemical Hazard. This pump is used for transferring many types of potentially dangerous chemicals. Always wear protective clothing, eye protection and follow standard safety procedures when handling corrosive or personally harmful materials. Proper procedures should be followed for draining and decontaminating the pump before disassembly and inspection of the pump. There may be small quantities of chemicals present during inspection.

 **WARNING:** Magnetic force hazard. This pump should only be disassembled and assembled using the recommended procedures. The magnetic attraction is powerful enough to rapidly pull the motor end and the wet end together. Do not place fingers between the mating surfaces of the motor and wet ends to avoid injuries. Keep the drive magnet and impeller assembly away from metal chips or particles.

Stop the pump, lock out the motor starter, close all the valves that are connected to the pump, and drain/decontaminate the pump.

 **WARNING:** The pump must be thoroughly flushed of any hazardous materials and all internal pressure relieved prior to opening the pump. Allow the pump to reach ambient temperatures prior to performing maintenance.

1. Secure the pump/motor to the bench with the adapter foot hanging over the edge. Remove (4) 1/2" socket head cap screws, lock washers and flat washers (items 14, 15, 16) securing the pump to the motor. Use 3/8" Allen wrench or 3/8" hex socket on universal joint.

2. Firmly grab the motor adapter and pull straight out to dis-engage the motor and pump. See figure 10.

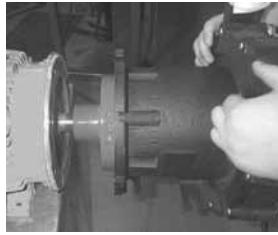

Figure 10

NOTE: If the pump has the optional o-ring sealing option (available on 184 and 215 frame pumps only), make sure o-ring (item 8B) does not fall out of the motor adapter (motor end).

3. Place pump on bench with housing (item 1) facing up. Using a 19 mm socket, remove (10) M12 hex head cap screws, lock washers and flat washers (items 11, 12, 13). See figure 11.
4. Pull housing straight up to remove. Impeller shaft (item 5) may be lodged in the front shaft support. Inspect housing for signs of wear or damage. Look for signs of rubbing, cracked thrust ring or damage to front shaft support. See figure 12.
5. Remove impeller/inner drive assembly (items 3A, 3, 4, 4A).



Figure 11



Figure 12

See figure 13. Inspect impeller and drive for signs of wear or damage. Look for signs of rubbing, damage and wear to the impeller and inner drive. Check the impeller thrust ring and bushing for wear. See figure 14.



Figure 13

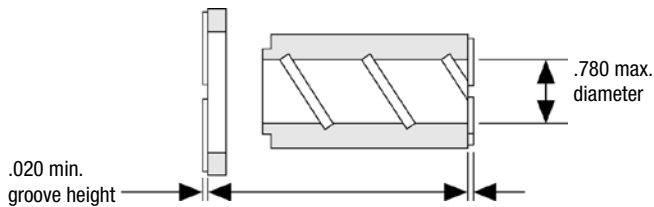

Figure 14

6. Remove the impeller shaft (item 5) from the barrier and check for signs of cracking, chipping, scoring or wear. See figure 15.
7. Remove the barrier (item 7) from the motor adapter (item 8) (make sure the spindle has been removed). If necessary, gently tap on the backside of the barrier with a soft rod (wood, plastic, etc). Inspect the inside and outside of the barrier for signs of rubbing. See figure 16.



Figure 15



Figure 16

8. Remove the o-ring (item 6) from the barrier and inspect for chemical attack, swelling, brittleness, cuts, etc.
9. Visually inspect the outer drive (item 9) for rubbing, damage, corrosion or loose magnets.

NOTE: Inspect the o-ring (item 8A), for chemical attack, swelling, brittleness, cuts, etc. Both NEMA and IEC pumps have o-ring item 8A. If the pump has the optional o-ring sealing option (available on 184 and 215 frame pumps only), inspect o-ring item 8B (and item 10A if 215 frame).

Outer Drive Replacement

1. Remove the setscrews (item 9B) from the side of the drive (NEMA motors) or the bolt, lock washer and flat washer (items 17, 18, 19) from the center of the drive (metric motors).

⚠WARNING: Be careful, tools will want to be attracted to the magnets.

2. Remove the drive magnet from the motor shaft by gently prying up from the bottom of the drive.
3. To reinstall the drive or a new drive follow the instructions from "Section I – Assembly, Pumps without Motors, Steps 3 & 4".

Thrust Ring Replacement

1. Thrust ring (item 3A) is held in-place with a snap fit ridge. Using a razor knife or side cutters, cut a notch out of the thrust ring. Pull ring up and out of the holder. See figures 17 and 18.
2. To reinstall, align the two flats on the thrust ring with the flats in the bore of the impeller. Using a piece of wood press into place using an arbor press until the thrust ring is completely seated in the impeller.

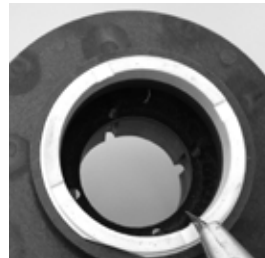

Figure 17

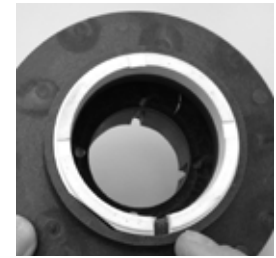

Figure 18

Bushing Replacement

1. To remove the bushing, place the impeller/inner drive assembly (items 3A, 3, 4, 4A) with the impeller facing up in an arbor press. If necessary support the bottom of the assembly with blocks to allow the bushing to fall out. Insert a 1" (25.4mm) diameter plastic or wooden shaft through the impeller and press bushing out. See figure 19.
2. To replace bushing, place the assembly on a flat surface with the impeller thrust ring face down. With the slotted face of the bushing facing the rear of the inner drive, align the flat in the bushing with the flat in the inner drive magnet. See figure 20. Gently push until bushing bottoms out.



Figure 19



Figure 20

Impeller Replacement

1. To remove the impeller from the inner drive magnet, gently pry off by hand or lightly tap on the back of the impeller.
2. To install a new impeller, place the inner drive magnet assembly face up. Line up the patterns on the impeller with the ones on the inner drive magnet so they match and press into place by hand. An arbor press can also be used to press the impeller on the inner drive. Place a piece of wood over the top of the impeller thrust ring and push down on the impeller until it is completely seated in the inner drive.

Reassembly

1. Lubricate the o-ring (item 8A) with a chemically compatible lubricant and install in the groove in the motor adapter.
2. Install the barrier (item 7) into the motor adapter (item 8). Press firmly to ensure that the barrier is completely seated.
3. Install o-ring (item 6) in groove in barrier.
4. Install impeller shaft (item 5) into barrier by aligning flats on the shaft with the ones in the barrier. Make sure it is completely seated. See figure 21.



Figure 21

5. Carefully install the impeller/inner drive assembly (items 3A, 3, 4, 4A) by sliding it over the impeller shaft in the barrier. It is normal for the impeller/inner drive to pop up a slight amount due to magnetic forces. See figures 22 and 23.



Figure 22



Figure 23

6. Install the impeller housing (item 1). Make sure the discharge is in the correct orientation in relation to the motor adapter pump foot. Align the shaft in the barrier with the front shaft support in the impeller housing. Press down to push the impeller/inner drive magnet assembly into position. Holding the impeller housing with one hand, install and finger-tighten two bolts lock washers and flat washers (items 11, 12, 13) in opposite locations. See figure 24.
7. Install the remaining bolts, lock washers and flat washers finger tight.
8. Using a 19 mm socket, tighten all the bolts evenly using a star pattern. Tighten to 240 in-lb (27.1 N-m)
9. Reinstall the pump on the motor/drive magnet following instructions from "Section I – Assembly, Pumps without Motors, Steps 5 & 8".



Figure 24

DB22 PART NUMBER EXPLANATION

NOTE: Pump end includes wetted components, drive magnet and motor adapter; wet end includes wetted components only.

Part Number Explanation

Base model number contains standard components. Where standard components aren't suitable, add the alternative component code letter after the base model number to substitute components. Example: DB22P-E-U-21 is constructed of the listed base model components except it has an EPDM O-ring, union connections, and a 213TC motor adapter.

The model number is on the serial number label located on the motor adapter. The model number contains a base model that features certain standard components. Compare the model number on the pump to the adjacent chart to determine if the pump contains any alternate components. Model numbers containing "P" have primary components molded from polypropylene. Model numbers containing "V" have primary components molded from PVDF.

Base Model Numbers: DB22P, DB22V

Alternative Components Price Adders											
Component	Base		Alternative	Code							
Bushing	Carbon	or	PTFE	T							
O-ring	Viton	or	EPDM	E							
			Simriz	S							
			Kalrez	K							
Connection	NPT	or	BSP	B							
			Union	U							
			Steel Enforced Flange	Fs							
			2" x 2" FRP flange	Ff							
			3" x 2" FRP flange	3 x 2							
Impeller Style	Closed		Open - see 8-16 below (8-11 60 Hz/ 12 - 16 50 Hz)								
Impeller	1 (60 Hz) 7.25"	or		1A	2	2A	2B	2C	3	3A	3B
				7.13"	7.00"	6.88"	6.75"	6.63"	6.50"	6.38"	6.25"
			3C	4	4A	4b	4C	5	5A	5B	5C
			6.13"	6.00"	5.88"	5.75"	5.63"	5.50"	5.38"	5.25"	5.13"
			6	6A	6B	6c	7	8	8A	8B	8C
			5.00"	4.88"	4.75"	4.63"	4.50"	6.00"	5.88"	5.75"	5.63"
			9	9A	9B	9C	10	10A	10B	10C	11
			5.50"	5.38"	5.25"	5.13"	5.00"	4.88"	4.75"	4.63"	4.50"
			12	13	13A	13B	13C	14	14A	14B	14C
			7.13"	7.00"	6.88"	6.75"	6.63"	6.50"	6.38"	6.25"	6.13"
15	15A	15B	15C	16							
6.00"	5.88"	5.75"	5.63"	5.50"							
Note: Impellers 1-7 are closed (50 and 60 Hz); 8-11 are open (60 Hz); 12-16 are open (50 Hz)											
Magnet (Upgrade for specific gravity corrections)	8-pole Up to 13 HP (60 Hz) ; 7.5 kW (50 Hz)	or	No Upgrade Available.								
Motor Adaptor	182-184TC NEMA	or	145TC NEMA				145				
			213-215TC NEMA				21				
			IEC 90/B14				94				
			IEC 100/B14				04				
			IEC 112/B14				24				
			IEC 132/B14				34				
			IEC 90/B5				95				
			IEC 100/B5				05				
			IEC 112/B5				25				
			IEC 132/B5				35				
Gas engine mounting				Ge							
Specials	Not Standard		SiC bushing/shaft				Ss				
			SiC bushing/impeller thrust ring/shaft				Si				
			Hastelloy shaft				Hs				
			Titanium Hardware				Ti				
			Non-sparking ring				Ns				
			O-ring vapor protection kit Viton (NEMA)				Vv				
O-ring vapor protection kit EPDM (NEMA)				Ve							
Motor	Not Standard		Contact factory or distributor								

DB22 EXPLODED VIEW PARTS DIAGRAM

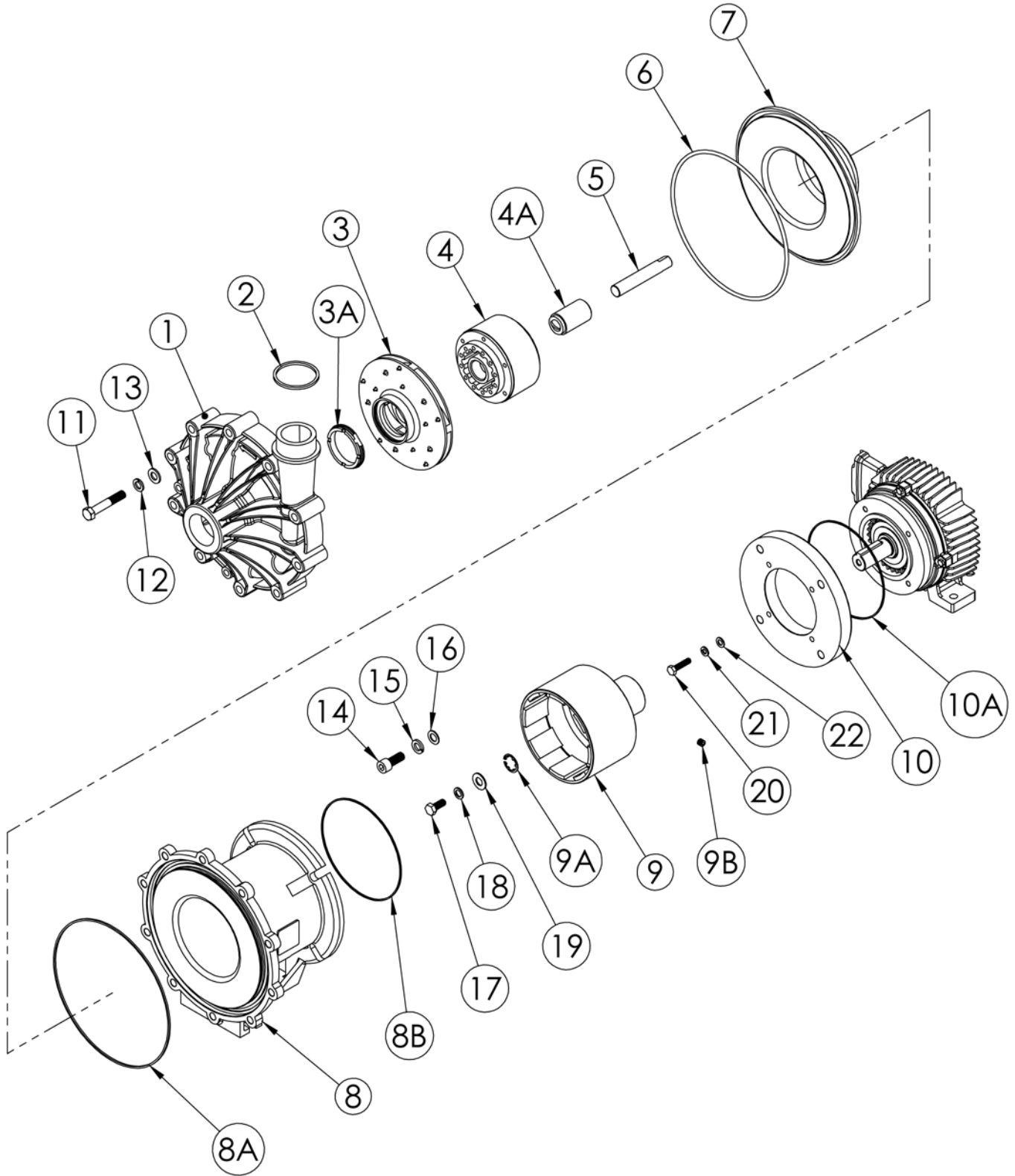

DB22 SPARE PARTS LIST

Item	Qty	Description	Polypropylene	PVDF		
1	1	Housing				
		NPT Threads & Ceramic Ring - 2" x 2"	106403	106403-1		
		BSP Threads & Ceramic Ring - 2" x 2"	106403-2	106403-3		
		FRP Flanges & Ceramic Ring - 2" x 2"	106478	106478-1		
		Fiberglass Flanges - 3" x 2"	107115	107115-1		
		Steel Flanges & Ceramic Ring - 2" x 2"	106478-2	106478-3		
		Unions & Ceramic Ring - 2" x 2"	106481	106481-1		
		NPT Threads & SiC Ring - 2" x 2"	106471	106471-1		
		BSP Threads & SiC Ring - 2" x 2"	106471-2	106471-3		
		FRP Flanges & SiC Ring - 2" x 2"	106748	106748-1		
		Steel Flanges & SiC Ring - 2" x 2"	106748-2	106748-3		
		Unions & SiC Ring - 2" x 2"	106755	106755-1		
2	1	Discharge O-ring (BSP housings only)	EPDM	105084		
			Viton	105083		
			Simriz	106948		
			Kalrez	106947		
3	1	Impeller Assemblies with Thrust Ring				
		DB22 Closed Impeller w/ Fluorosint Thrust Ring	Imp No.	Imp. Dia. inches		
			#1	7.25	106472	106472-1
			#1A	7.13	106472-14	106472-15
			#2	7.00	106472-2	106472-3
			#2A	6.88	106472-16	106472-17
			#2B	6.75	106472-18	106472-19
			#2C	6.63	106472-20	106472-21
			#3	6.50	106472-4	106472-5
			#3A	6.38	106472-22	106472-23
			#3B	6.25	106472-24	106472-25
			#3C	6.13	106472-26	106472-27
			#4	6.00	106472-6	106472-7
			#4A	5.88	106472-28	106472-29
			#4B	5.75	106472-30	106472-31
			#4C	5.63	106472-32	106472-33
			#5	5.50	106472-8	106472-9
			#5A	5.38	106472-34	106472-35
			#5B	5.25	106472-36	106472-37
			#5C	5.13	106472-38	106472-39
			#6	5.00	106472-10	106472-11
			#6A	4.88	106472-40	106472-41
#6B	4.75	106472-42	106472-43			
#6C	4.63	106472-44	106472-45			
#7	4.50	106472-12	106472-13			
3	1	DB22 Closed Impeller w/ Silicon Carbide Thrust Ring	#1	7.25	106473	106473-1
			#1A	7.13	106473-14	106473-15
			#2	7.00	106473-2	106473-3
			#2A	6.88	106473-16	106473-17
			#2B	6.75	106473-18	106473-19
			#2C	6.63	106473-20	106473-21
			#3	6.50	106473-4	106473-5
			#3A	6.38	106473-22	106473-23
			#3B	6.25	106473-24	106473-25
			#3C	6.13	106473-26	106473-27
			#4	6.00	106473-6	106473-7
			#4A	5.88	106473-28	106473-29
			#4B	5.75	106473-30	106473-31
			#4C	5.63	106473-32	106473-33
			#5	5.50	106473-8	106473-9
			#5A	5.38	106473-34	106473-35
#5B	5.25	106473-36	106473-37			

Item	Qty	Description	Imp. No.	Imp. Dia. Inches	Polypropylene	PVDF
3	1	DB22 Closed Impeller w/ Silicon Carbide Thrust Ring	#5C	5.13	106473-38	106473-39
			#6	5.00	106473-10	106473-11
			#6A	4.88	106473-40	106473-41
			#6B	4.75	106473-42	106473-43
			#6C	4.63	106473-44	106473-45
			#7	4.50	106473-12	106473-13
			3	1	DB22 Open Impeller w/ Fluorosint Thrust Ring	#8
#8A	5.88	106469-26				106469-27
#8B	5.75	106469-28				106469-29
#8C	5.63	106469-30				106469-31
#9	5.50	106469-8				106469-9
#9A	5.38	106469-32				106469-33
#9B	5.25	106469-34				106469-35
#9C	5.13	106469-36				106469-37
#10	5.00	106469-10				106469-11
#10A	4.88	106469-38				106469-39
#10B	4.75	106469-40				106469-41
#10C	4.63	106469-42				106469-43
#11	4.50	106469-12				106469-13
#12	7.13	106469				106469-1
#13	7.00	106469-2				106469-3
#13A	6.88	106469-14				106469-15
#13B	6.75	106469-16				106469-17
#13C	6.63	106469-18				106469-19
#14	6.50	106469-4				106469-5
#14A	6.38	106469-20				106469-21
#14B	6.25	106469-22				106469-23
#14C	6.13	106469-24	106469-25			
#15	6.00	106469-6	106469-7			
#15A	5.88	106469-26	106469-27			
#15B	5.75	106469-28	106469-29			
#15C	5.63	106469-30	106469-31			
#16	5.50	106469-8	106469-9			
3	1	DB22 Open Impeller w/ Silicon Carbide Thrust Ring	#8	6.00	106470-6	106470-7
			#8A	5.88	106470-26	106470-27
			#8B	5.75	106470-28	106470-29
			#8C	5.63	106470-30	106470-31
			#9	5.50	106470-8	106470-9
			#9A	5.38	106470-32	106470-33
			#9B	5.25	106470-34	106470-35
			#9C	5.13	106470-36	106470-37
			#10	5.00	106470-10	106470-11
			#10A	4.88	106470-38	106470-39
			#10B	4.75	106470-40	106470-41
			#10C	4.63	106470-42	106470-43
			#11	4.50	106470-12	106470-13
			#12	7.13	106470	106470-1
			#13	7.00	106470-2	106470-3
#13A	6.88	106470-14	106470-15			
#13B	6.75	106470-16	106470-17			

DB22 SPARE PARTS LIST (continued)

Item	Qty	Description	Imp. No.	Imp. Dia. inches	Polypropylene	PVDF
3	1	DB22 Open Impeller w/ Silicon Carbide Thrust Ring	#13C	6.63	106470-18	106470-19
			#14	6.50	106470-4	106470-5
			#14A	6.38	106470-20	106470-21
			#14B	6.25	106470-22	106470-23
			#14C	6.13	106470-24	106470-25
			#15	6.00	106470-6	106470-7
			#15A	5.88	106470-26	106470-27
			#15B	5.75	106470-28	106470-29
			#15C	5.63	106470-30	106470-31
3A	1	DB22 Closed Impeller Thrust Ring Only	Fluorosint		J103899	
			SiC		J104170	
		DB22 Open Impeller Thrust Ring Only	Fluorosint		J101460	
			SiC		J101460-1	
4	1	Impeller Drive Assembly				
		With Carbon Bushing			106476	106476-1
		With PTFE Bushing			106476-2	106476-3
		With SiC Bushing			106476-4	106476-5
4A	1	Impeller Bushing Only	Carbon		J103917-1	
			Filled PTFE		106757	
			SiC		106757-1	
5	1	Impeller Shaft	Ceramic		106450	
			SiC		106450-1	
			Hastelloy C		106450-2	
6	1	Barrier			106400	106400-1
7	1	Housing O-ring	EPDM		106765	
			Viton		106764	
			Simriz		106767	
			Kalrez		106766	
8	1	Motor Adapter	Standard		106414-1	106414-2
			ATEX		106794	106794-1
8A	1	Front Motor Adapter O-Ring	Buna		106844	
			EPDM		106845	
			Viton		106846	
8B	1	Rear Motor Adapter O-Ring (NEMA motors only)	Buna		106847	
			EPDM		106848	
			Viton		106849	
9	1	Outer Drive Magnet Assembly				
		184TC Frame (Includes Set Screws and Retaining Ring)			106453	
		213TC Frame (Includes Set Screws and Retaining Ring)			106453-1	
		90 Frame (Includes Retaining Ring)			106457	
		100/112 Frame (Includes Retaining Ring)			106457-1	
		132 Frame (Includes Retaining Ring)			106457-2	
		145TC Frame (includes Set Screws and Retaining Ring)			106457-3	

DB22 SPARE PARTS LIST (continued)

Item	Qty	Description	Polypropylene	PVDF	
9A	1	Retaining Ring Only	145 Frame	105709	
			184TC Frame	105710	
			213TC Frame	106454	
			90 Frame	105712	
			100/112 Frame	105710	
			132 Frame	106468	
9B	2	Set Screws (NEMA Motor Only)		J101084	
10	1	Motor Adapter Flange	213/215TC	106775	106775-1
			90 B14	106781	106781-1
			90 B5	106780	106780-1
			100/112 B14/145TC Frame	106777	106777-1
			100/112 B5	106776	106776-1
			132 B14	106779	106779-1
			132 B5	106778	106778-1
10A	1	Motor Adapter Flange O-Ring (NEMA 213/215 Frame Motors Only)	Buna	106851	
			EPDM	106852	
			Viton	106853	
HARDWARE					
Item	Qty	Description	Stainless Steel	Titanium	
11	10	Housing Bolt	106501	106502	
12	10	Housing Lock Washer	106503	106504	
13	10	Housing Flat Washer	106505	106506	
14	4	Motor Adapter Bolt	Standard	106495	106498
			213/215 TC	106511	106512
15	4	Motor Adapter Lockwasher	J101023	105762	
16	4	Motor Adapter Flatwasher	106497	106500	
17	1	Drive Bolt (IEC motors only)	90 Frame	105770	105771
			100/112 Frame	105774	105775
			132 Frame	106507	106508
18	1	Drive Lockwasher (IEC motors only)	90 Frame	J102282	J103847
			100/112 Frame	105757	105758
			132 Frame	106503	106504
19	1	Drive Flatwasher (IEC motors only)	90 Frame	105722	105772
			100/112 Frame	J101360	106200
			132 Frame	106509	106510
20	4	Motor Adapter Flange Bolt (IEC and 145TC frame motors only)	90 Frame	J103781	106513
			100/112 Frame	105589	106514
			132 Frame	106774	106775
			145TC Frame	J101000	107740
21	4	Motor Adapter Lockwasher (IEC motors only)	90 Frame	J102282	J103847
			100/112 Frame	J102282	J103847
			132 Frame	105757	105758
22	4	Motor Adapter Flatwasher (IEC motors only)	90 Frame	J101293	J103845
			100/112 Frame	J101293	J103845
			132 Frame	N/A	N/A

Troubleshooting

General Notes:

- Do not pump liquids containing ferrous metal fines.
- If magnets decouple, stop pump immediately. Operating the pump with the magnets decoupled will eventually weaken the magnets.
- Contact our Technical Service Department If you have any questions regarding product operation or repair:
Phone: 1-800-888-3743
E-mail: techservice@finishthompson.com

No or Insufficient Discharge

- Air leaks in suction piping
- Pump not primed
- System head higher than anticipated
- Closed valve
- Viscosity or specific gravity too high
- Motor too large for magnet coupling rating (magnets uncoupled)
- Suction lift too high or insufficient NPSH
- Clogged suction line or impeller vanes
- Motor rotation incorrect (correct rotation when viewed from the fan end is clockwise)

Insufficient Pressure

- Air or gas in liquid
- Impeller diameter too small
- System head lower than anticipated
- Motors speed insufficient (too low) or motor rotation incorrect (correct rotation when viewed from the fan end is clockwise)

Loss of Prime

- Leak in suction piping
- Foot valve or suction opening not submerged enough
- Foot valve too small or leaking
- Air or gas in liquid
- Foreign matter in impeller
- Leaking valve. Suction lift too high or insufficient NPSHa.

Excessive Power Consumption

- Head lower than rating
- Excessive flow
- Specific gravity or viscosity too high.

Vibration/Noise

- Loose magnet
- Drive magnet rubbing
- Pump cavitating from improper suction or feed
- Motor or piping not properly secured
- Foreign object in impeller

Section V - Warranty

Finish Thompson, Inc (manufacturer) warrants this pump product to be free of defects in materials and workmanship for a period of five years from date of purchase by original purchaser. If a warranted defect, which is determined by manufacturer's inspection, occurs within this period, it will be repaired or replaced at the manufacturer's option, provided (1) the product is submitted with proof of purchase date and (2) transportation charges are prepaid to the manufacturer. Liability under this warranty is expressly limited to repairing or replacing the product or parts thereof and is in lieu of any other warranties, either expressed or implied. This warranty does apply only to normal wear of the product or components. This warranty does not apply to products or parts broken due to, in whole or in part, accident, overload, abuse, chemical attack, tampering, or alteration. The warranty does not apply to any other equipment used or purchased in combination with this product. The manufacturer accepts no responsibility for product damage or personal injuries sustained when the product is modified in any way. If this warranty does not apply, the purchaser shall bear all cost for labor, material and transportation.

Manufacturer shall not be liable for incidental or consequential damages including, but not limited to process down time, transportation costs, costs associated with replacement or substitution products, labor costs, product installation or removal costs, or loss of profit. In any and all events, manufacturer's liability shall not exceed the purchase price of the product and/or accessories.

Ordering Spare Parts

Spare parts can be ordered from your local distributor. Always refer to the pump model to avoid error.



FINISH THOMPSON INC.

921 Greengarden Road • Erie, PA 16501-1591 U.S.A.
Ph 814-455-4478 • Fax 814-455-8518
Email fti@finishthompson.com • www.finishthompson.com

Literature I.D. No. FT08-1023F
Part Number 106782, Rev 7

